

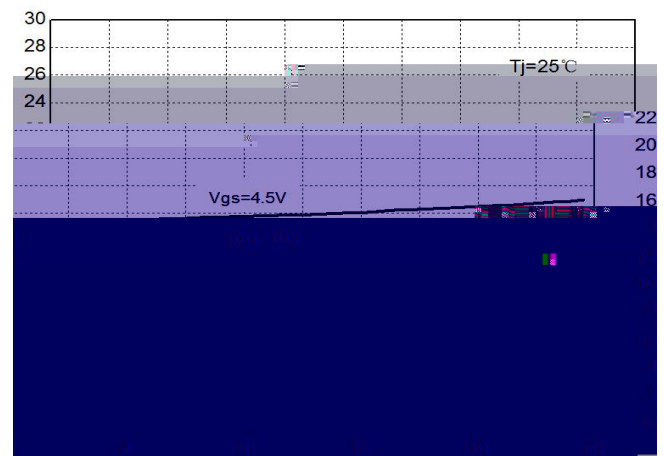

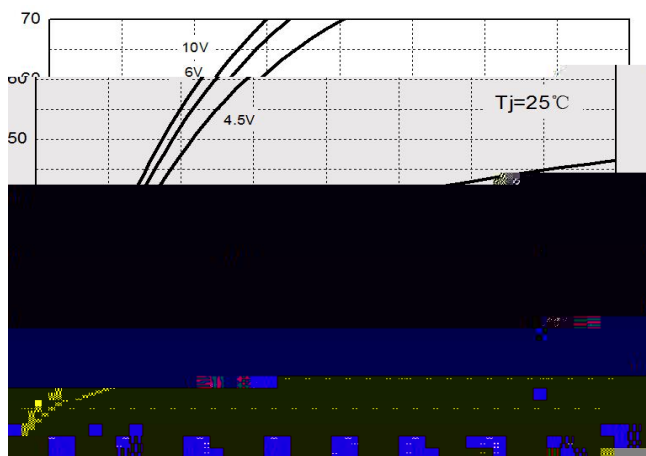

---

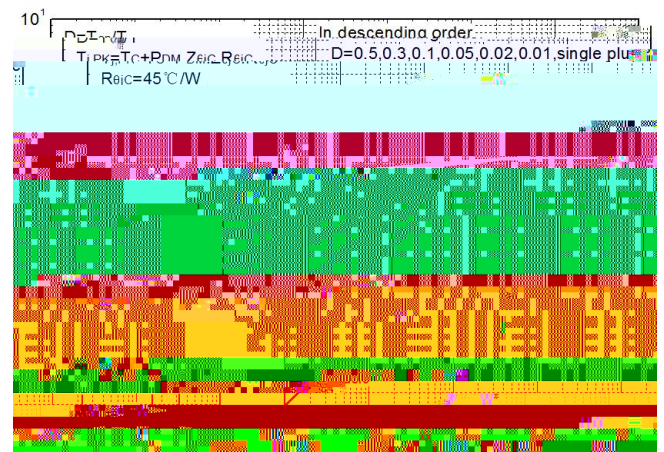
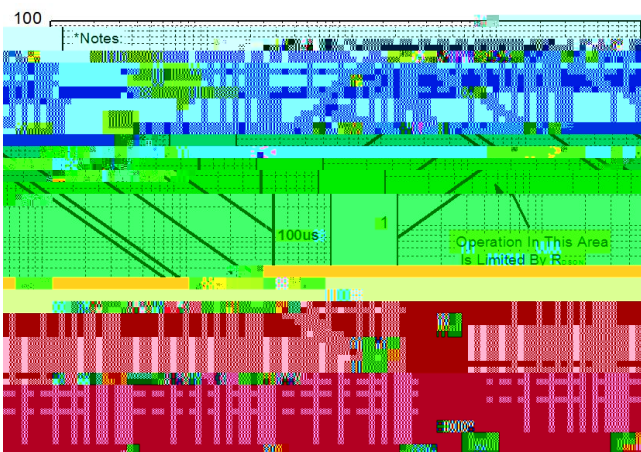
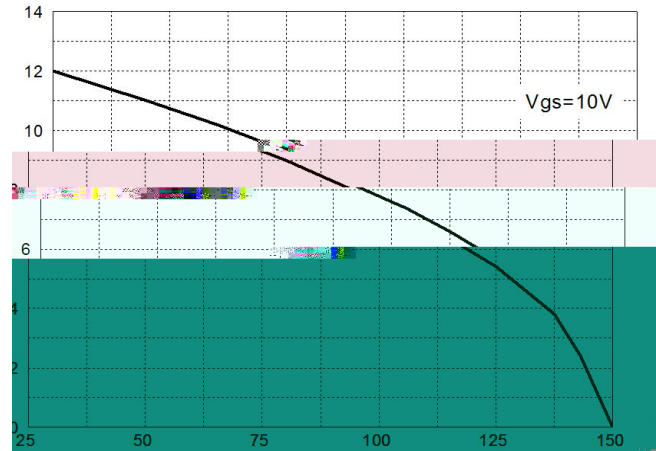
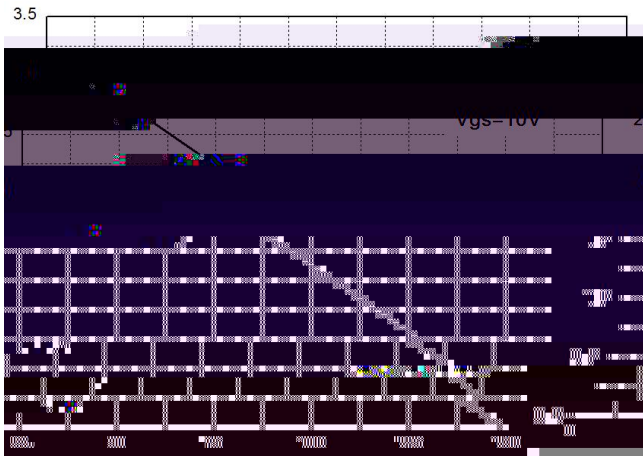

---

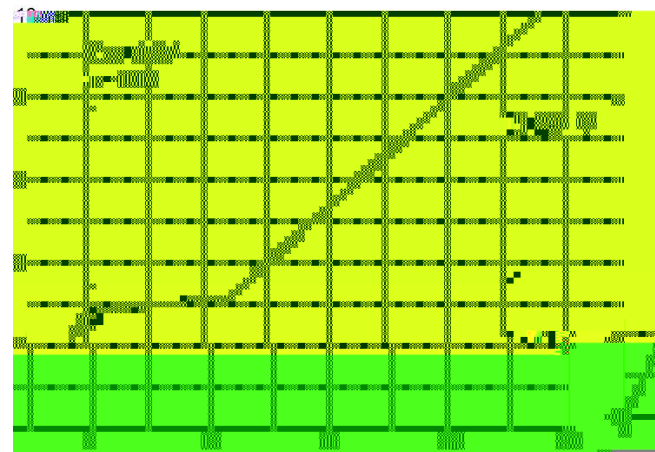
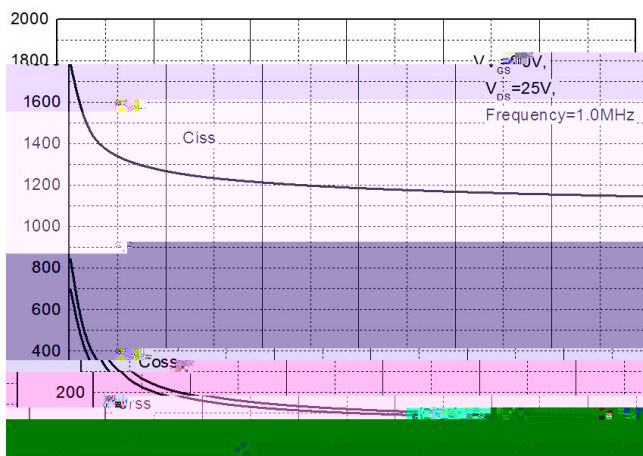
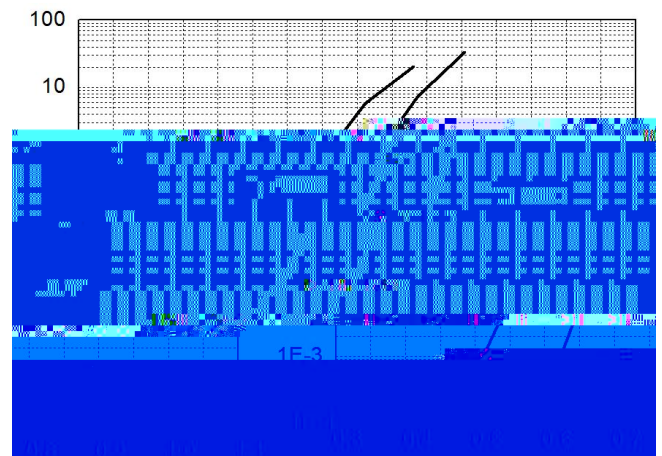
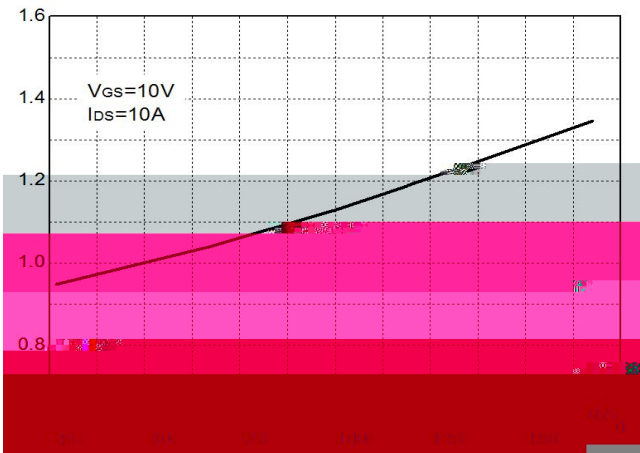

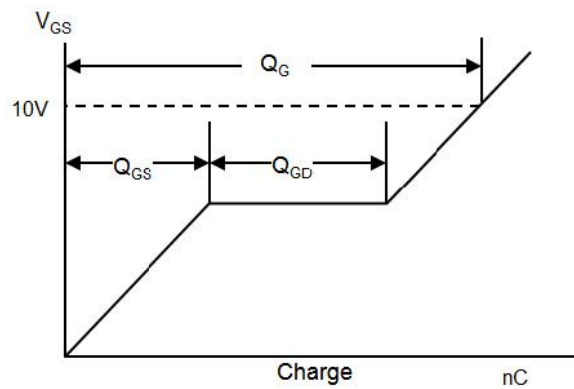
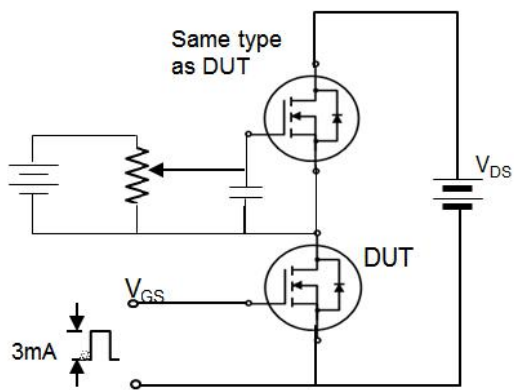
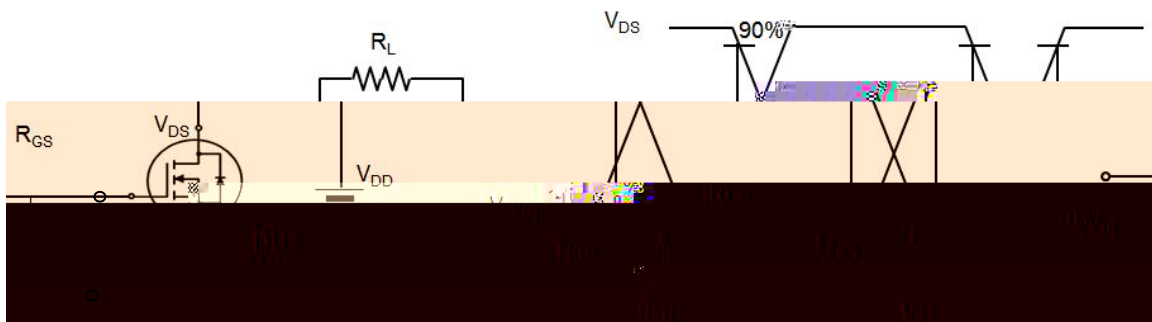
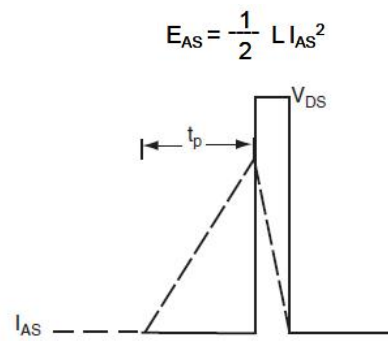
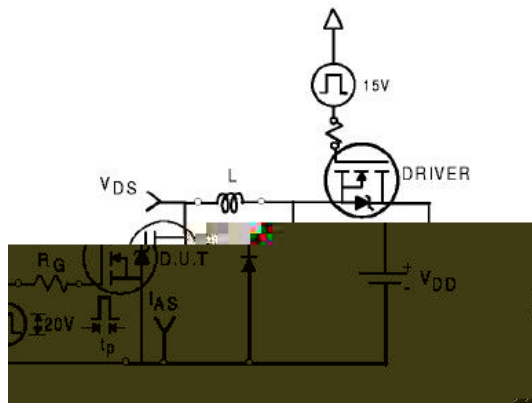

nC

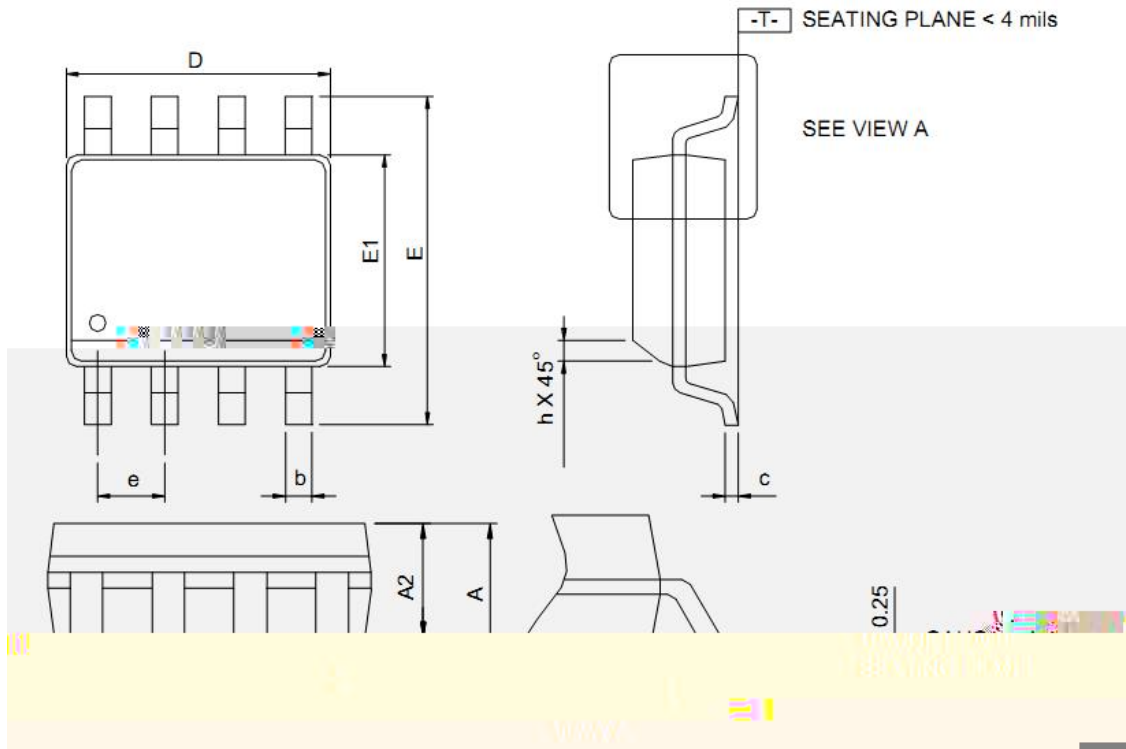

S	SOP-8L				RECOMMENDED LAND PATTERN
	MILLIMETERS		INCHES		
	MIN.	MAX.	MIN.	MAX.	
A	-	1.75	-	0.069	
1.27	0.010	0.05	0.004	0.010	









