

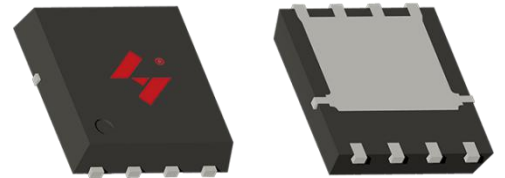

--

- 
- 
- 
- 

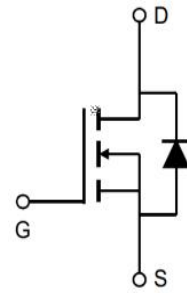

- 
- 



	
---	--

$\theta$			
$\theta$			

.. .

			0 0 1			
				.		
						m
						m



0 0 1

---

1

---

---



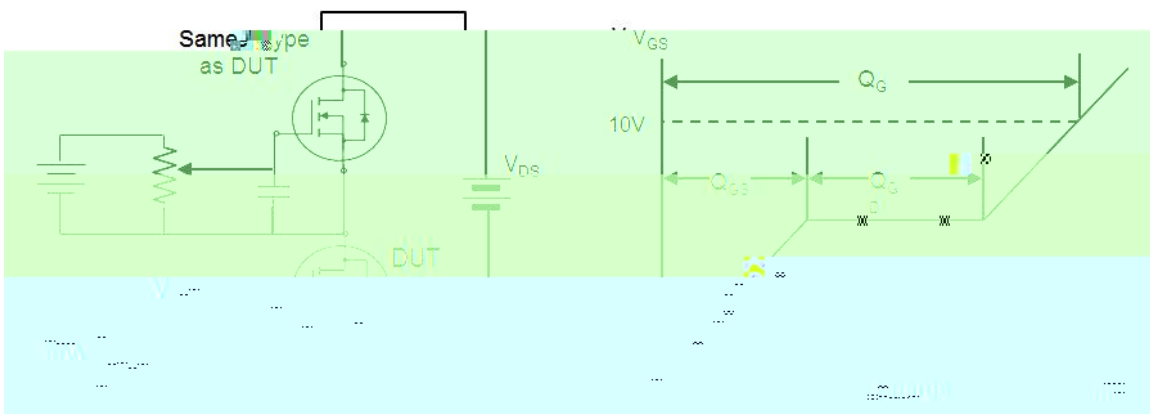
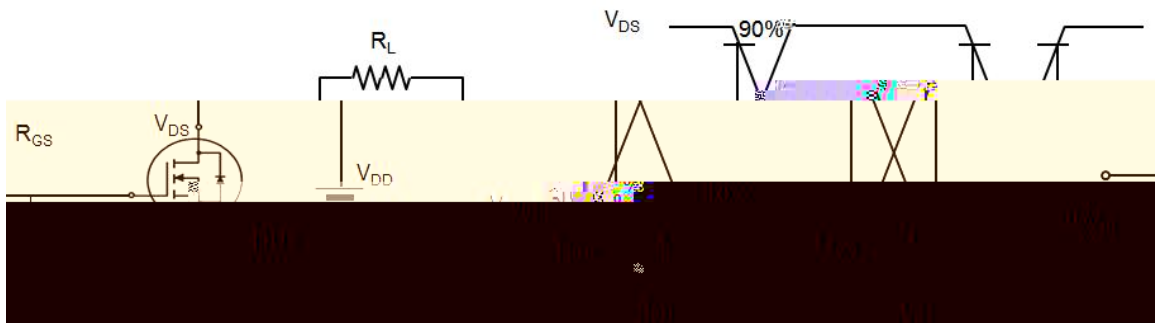
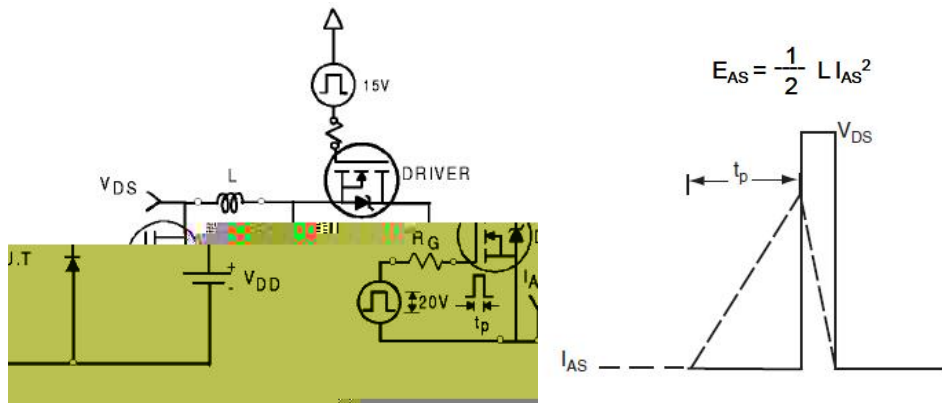

(

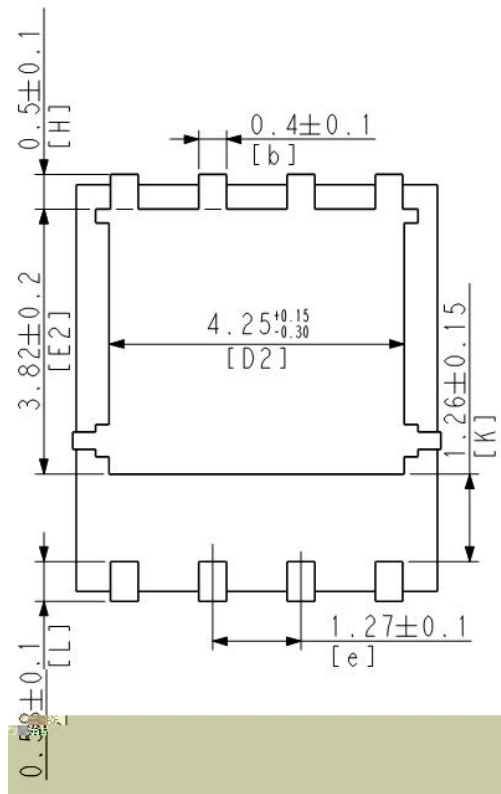
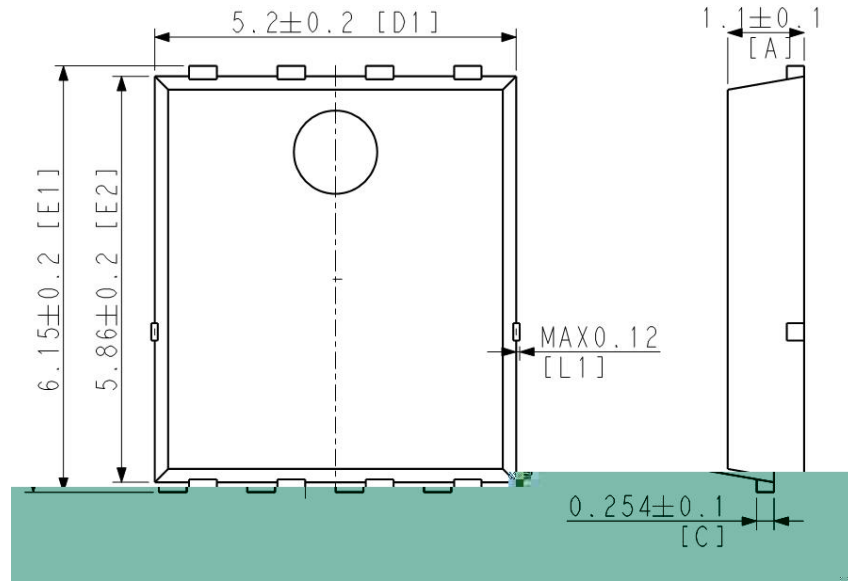





0 0 1

---

	0	0

0

0- 000

000

---