

N-Channel Enhancement Mode MOSFET

Feature

- 80V/105A
 $R_{DS(ON)}=5.5\text{ m}\Omega(\text{typ.})@V_{GS} = 10\text{V}$
- 100% Avalanche Tested
- Reliable and Rugged
- Lead-Free and Green Devices Available (RoHS Compliant)

Pin Description

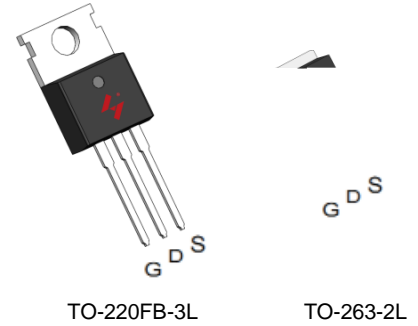

Applications

- Switching application
- Power management for inverter systems
- Motor control

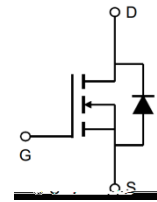

N-Channel MOSFET

Ordering and Marking Information

<div style="display: flex; justify-content: space-around;"> <div style="text-align: center;"> <div style="background-color: black; width: 15px; height: 15px; margin: 0 auto;"></div> <p>P</p> <p>G060N08</p> <p>XYMXXXXXX</p> </div> <div style="text-align: center;"> <div style="background-color: black; width: 15px; height: 15px; margin: 0 auto;"></div> <p>B</p> <p>G060N08</p> <p>XYMXXXXXX</p> </div> </div>	<p>Package Code</p> <p>P : TO-220FB-3L B : TO-263-2L</p> <p>Date Code</p> <p>XYMXXXXXX</p>
--	---

Note: HUAYI lead-free products contain molding compounds/die attach materials and 100% matte tin plate Termination finish; which are fully compliant with RoHS. HUAYI lead-free products meet or exceed the lead-free requirements of IPC/JEDEC J-STD-020 for MSL classification at lead-free peak reflow temperature. HUAYI defines “Green” to mean lead-free (RoHS compliant) and halogen free (Br or Cl does not exceed 900ppm by weight in homogeneous material and total of Br and Cl does not exceed 1500ppm by weight).

HUAYI reserves the right to make changes, corrections, enhancements, modifications, and improvements to this product and/or to this document at any time without notice.

Absolute Maximum Ratings

Symbol	Parameter		Rating	Unit
Common Ratings (Tc=25°C Unless Otherwise Noted)				
V _{DSS}	Drain-Source Voltage		80	V
V _{GSS}	Gate-Source Voltage		20	V
T _J	Junction Temperature Range		-55 to 175	°C
T _{STG}	Storage Temperature Range		-55 to 175	°C
I _S	Source Current-Continuous(Body Diode)	Tc=25°C	105	A
Mounted on Large Heat Sink				
I _{DM}	Pulsed Drain Current *	Tc=25°C	350	A
I _D	Continuous Drain Current	Tc=25°C	105	A
		Tc=100°C	74.2	A
P _D	Maximum Power Dissipation	Tc=25°C	125	W
		Tc=100°C	62.5	W
R _{θJC}	Thermal Resistance, Junction-to-Case		1.2	°C/W
R _{θJA}	Thermal Resistance, Junction-to-Ambient **		62.5	°C/W
E _{AS}	SinglePulsed-Avalanche Energy ***	L=0.3mH	225	mJ

Note: * Repetitive rating pulse width limited by max.junction temperature.

** Surface mounted on 1in2 FR-4 board.

*** Limited by T_{Jmax}, starting T_J=25°C, L = 0.3mH, R_C= 25Ω, V_{GS}=10V.

Electrical Characteristics(Tc =25°C Unless Otherwise Noted)

Symbol	Parameter	Test Conditions	HYG060N08NS1			Unit
			Min	Typ.	Max	
Static Characteristics						
BV _{DSS}	Drain-Source Breakdown Voltage	V _{GS} =0V, I _{DS} = 250μA	80	-	-	V
I _{DSS}	Drain-to-Source Leakage Current	V _{DS} = 80V, V _{GS} =0V	-			

Electrical Characteristics (Cont.) (Tc =25°C Unless Otherwise Noted)

Symbol	Parameter	Test Conditions	HYG060N08NS1			Unit
			Min	Typ.	Max	
Dynamic Characteristics						
R _G	Gate Resistance	V _{GS} =0V, V _{DS} =0V, F=1MHz	-	2.3	-	Ω
C _{iss}	Input Capacitance	V _{GS} =0V, V _{DS} = 25V, Frequency=1.0MHz	-	2950	-	pF
C _{oss}	Output Capacitance		-	1190	-	
C _{rss}	Reverse Transfer Capacitance		-	60	-	
t _{d(ON)}	Turn-on Delay Time	V _{DD} = 40V, R _G =4.0Ω, I _{DS} = 40A, V _{GS} = 10V	-	12	-	ns
T _r	Turn-on Rise Time		-	55	-	
t _{d(OFF)}	Turn-off Delay Time		-	34	-	
T _f	Turn-off Fall Time		-	65	-	
Gate Charge Characteristics						
Q _g	Total Gate Charge	V _{DS} = 64V, V _{GS} = 10V, I _{DS} = 40A	-	48	-	nC
Q _{gs}	Gate-Source Charge		-	15	-	
Q _{gd}	Gate-Drain Charge		-	13	-	

Note: *Pulse test pulse width ≤ 300us duty cycle ≤ 2%

Typical Operating Characteristics

Figure 1: Power Dissipation

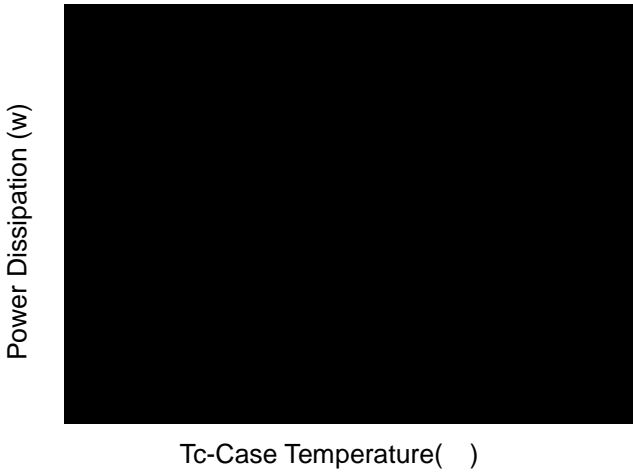

Figure 2: Drain Current

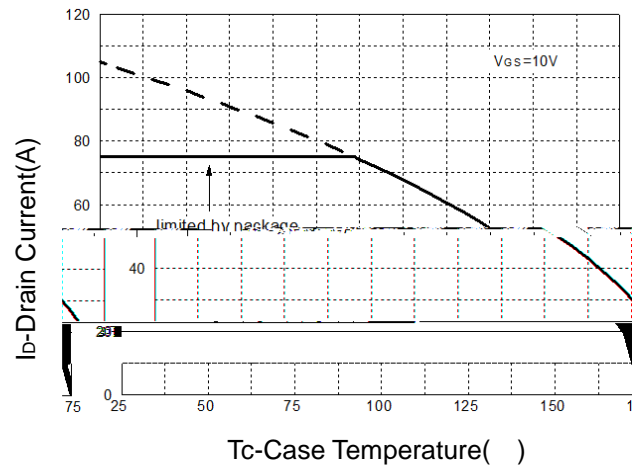

Figure 3: Safe Operation Area

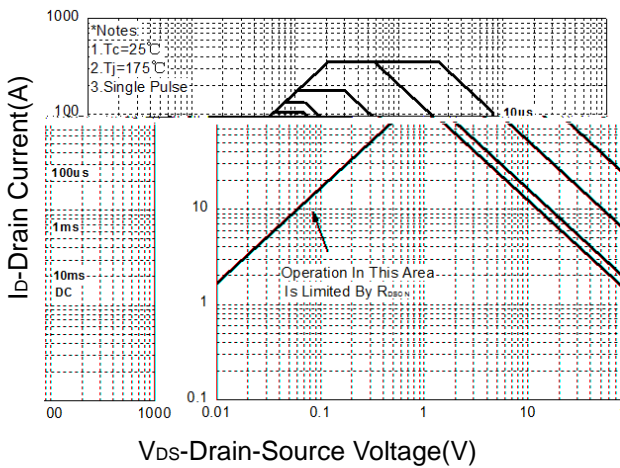

Figure 4: Thermal Transient Impedance

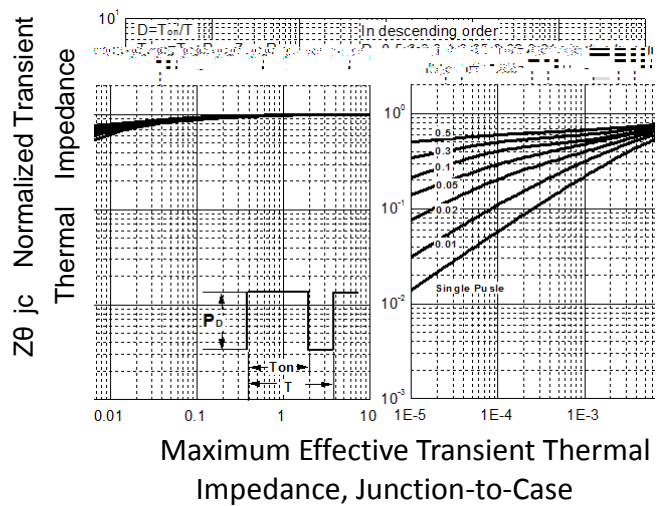

Figure 5: Output Characteristics

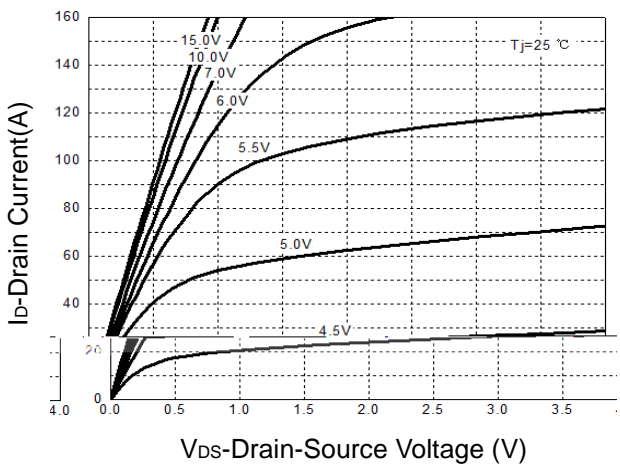
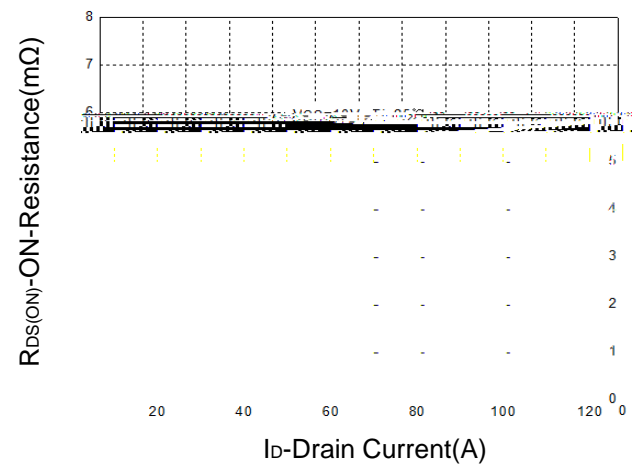

Figure 6: Drain-Source On Resistance



Typical Operating Characteristics(Cont.)

Figure 7: On-Resistance vs. Temperature

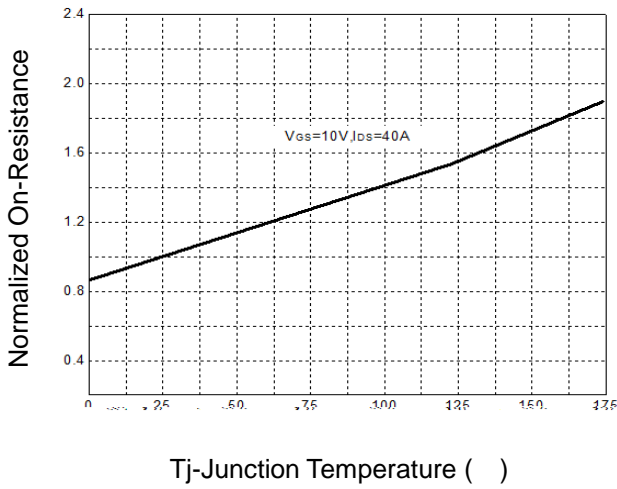

Figure 8: Source-Drain Diode Forward

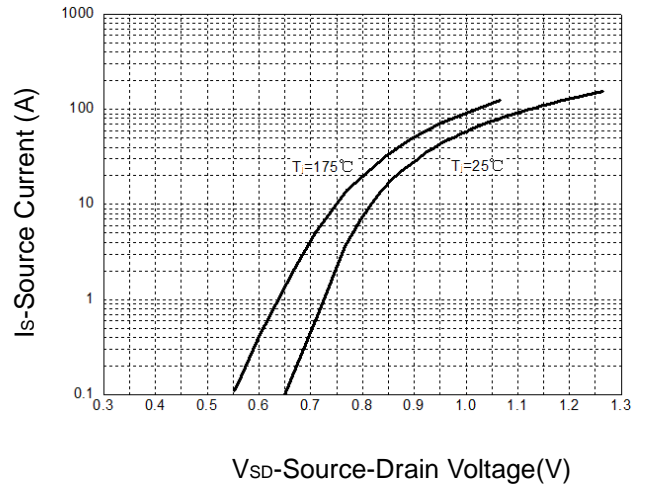

Figure 9: Capacitance Characteristics

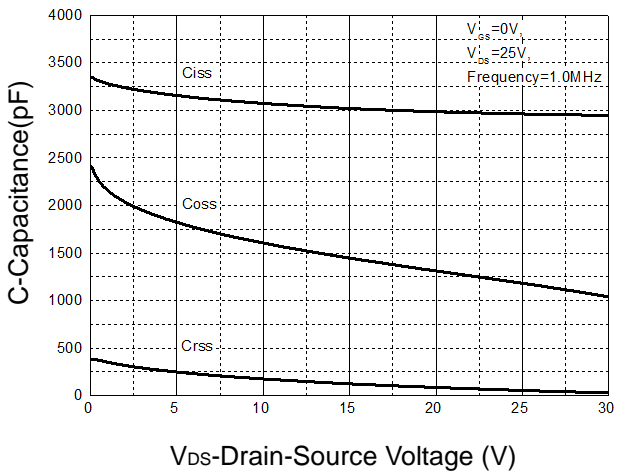
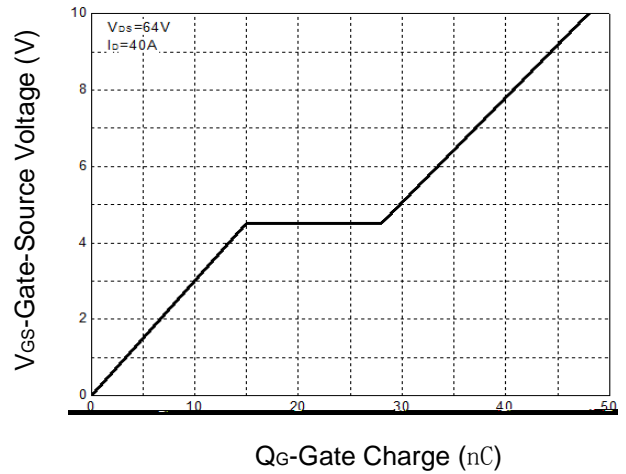
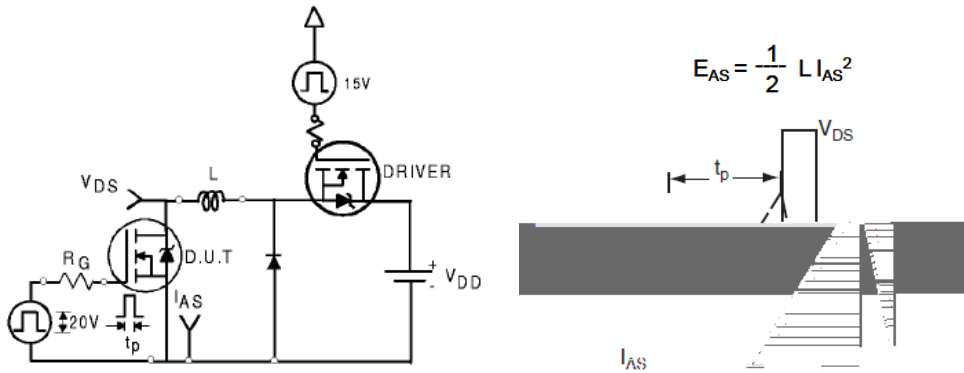

Figure 10: Gate Charge Characteristics



Avalanche Test Circuit



Switching Time Test Circuit

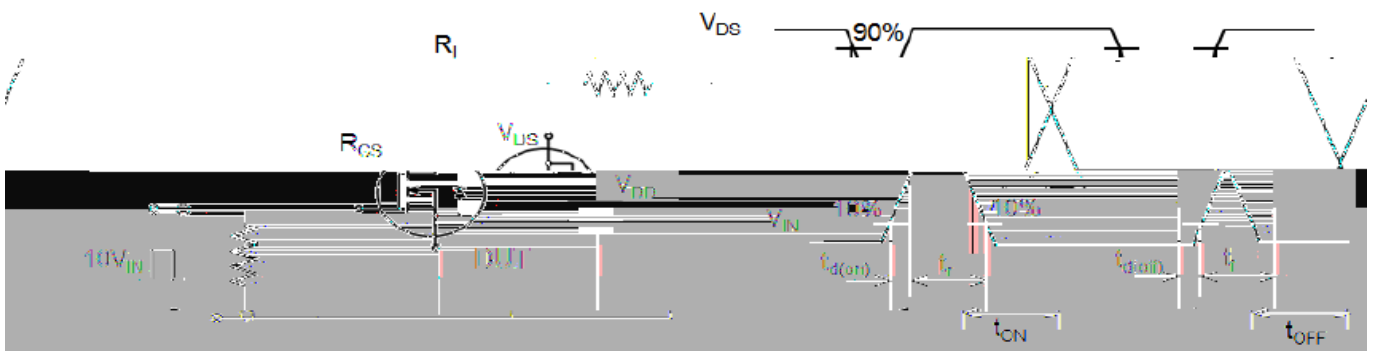

Gate Charge Test Circuit

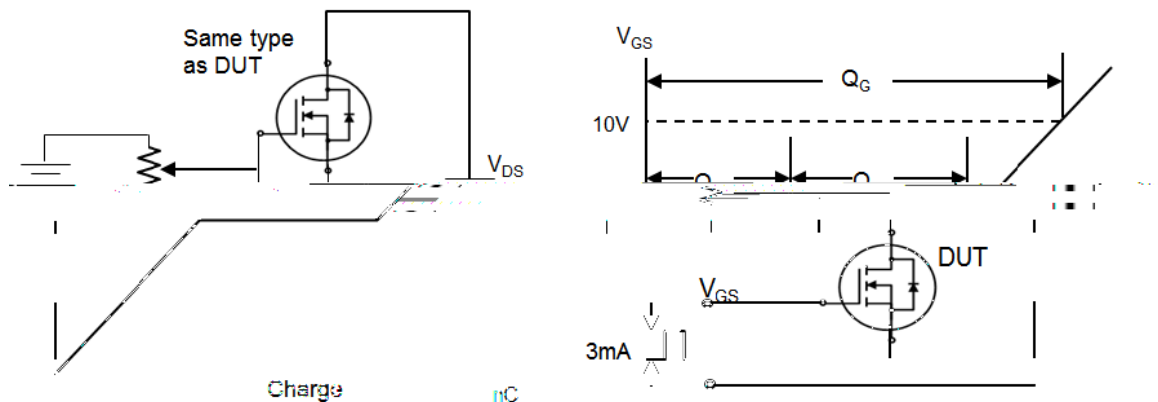

Device Per Unit

Package Type	Unit	Quantity
TO-220FB-3L	Tube	50

Package Information

TO-220FB-3L

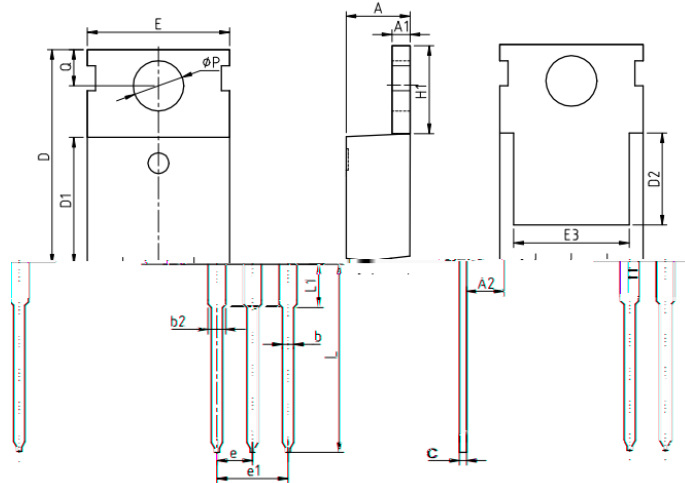

COMMON DIMENSIONS

SYMBOL	mm		
	MIN	NOM	MAX
A	4.37	4.57	4.77
A1	1.25	1.30	1.45
A2	2.20	2.40	2.60
b	0.70	0.80	0.95
b2	1.17	1.27	1.47
c	0.40	0.50	0.65
D	15.10	15.60	16.10
D1	8.80	9.10	9.40
D2	5.50	-	-
E	9.70	10.00	10.30
E3	7.00	-	-
e	2.54 BSC		
e1	5.08 BSC		
H1	6.25	6.50	6.85
L	12.75	13.50	13.80
L1	-	3.10	3.40
ΦP	3.40	3.60	3.80
Q	2.60	2.80	3.00

HYG060N08NS1P/B

Device Per Unit

Package Type	Unit	Quantity
TO-263-2L	Tube	50
TO-263-2L	Reel	800

Package Information

TO-263-2L

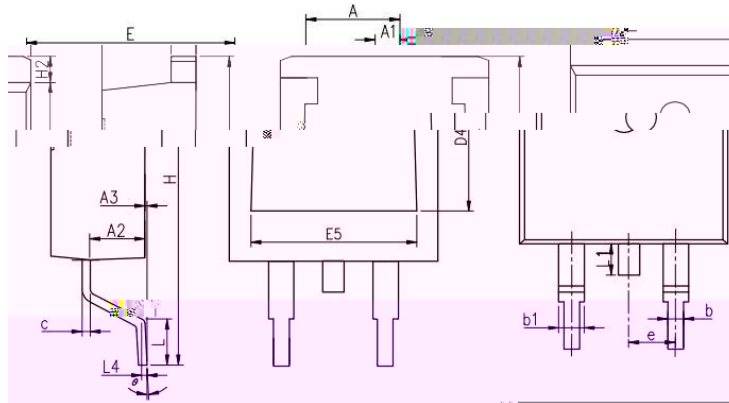

COMMON DIMENSIONS

Classification Profile

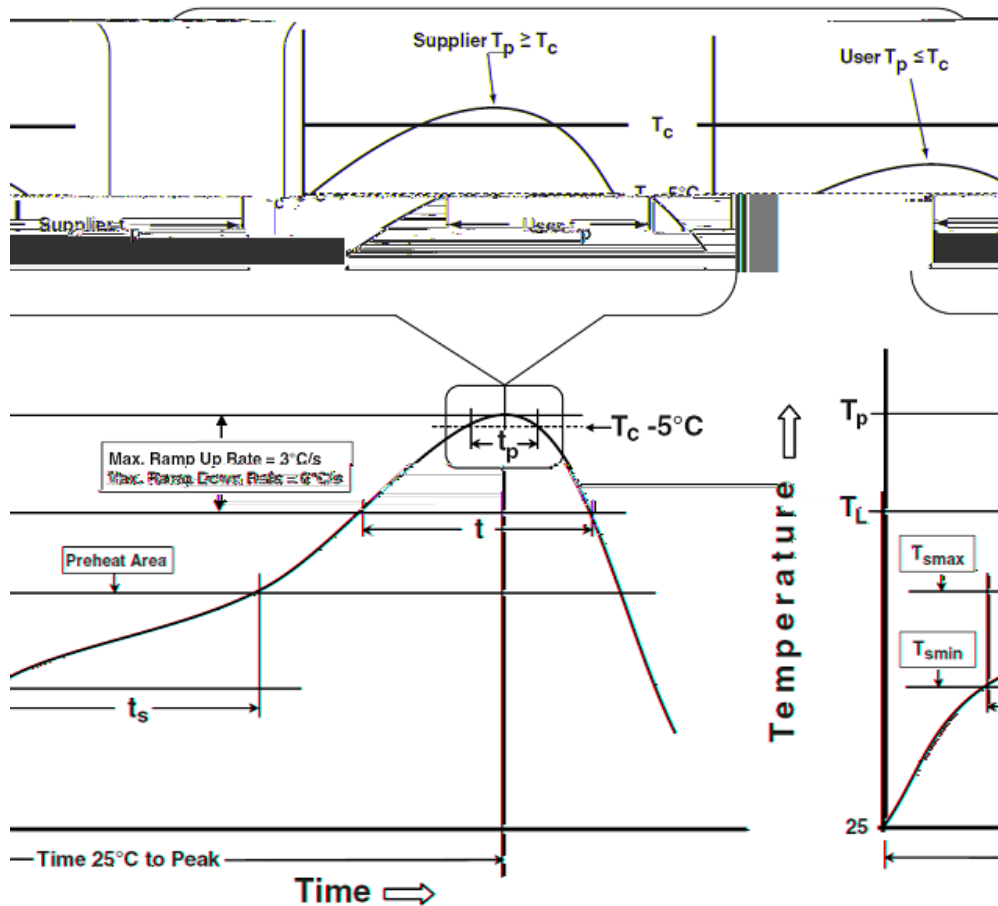

Classification Reflow Profiles

Profile Feature	Sn-Pb Eutectic Assembly	Pb-Free Assembly
Preheat & Soak		
Temperature min (T_{smin})	100 °C	150 °C
Temperature max (T_{smax})	150 °C	200 °C
Time (T_{smin} to T_{smax}) (t_s)	60-120 seconds	60-120 seconds
Average ramp-up rate (T_{smax} to T_P)	3 °C/second max.	3°C/second max.
Liquidous temperature (T_L)	183 °C	217 °C
Time at liquidous (t_l)	60-150 seconds	60-150 seconds
Peak package body Temperature (T_P)*	See Classification Temp in table 1	See Classification Temp in table 2
Time (t_p)** within 5°C of the specified classification temperature (T_c)	20** seconds	30** seconds
Average ramp-down rate (T_P to T_{smax})	6 °C/second max.	6 °C/second max.
Time 25°C to peak temperature	6 minutes max.	8 minutes max.

*Tolerance for peak profile Temperature (T_P) is defined as a supplier minimum and a user maximum.

** Tolerance for time at peak profile temperature (t_p) is defined as a supplier minimum and a user maximum.

