

P-Channel Enhancement Mode MOSFET

Feature

- z -60V/-20A
 $R_{DS(ON)} = 37\text{ m } (\text{typ.}) @ V_{GS} = -10\text{V}$
 $R_{DS(ON)} = 50\text{ m } (\text{typ.}) @ V_{GS} = -4.5\text{V}$
- z 100% avalanche tested
- z Reliable and Rugged
- z Halogen Free and Green Devices Available
 (RoHS Compliant)

Pin Description

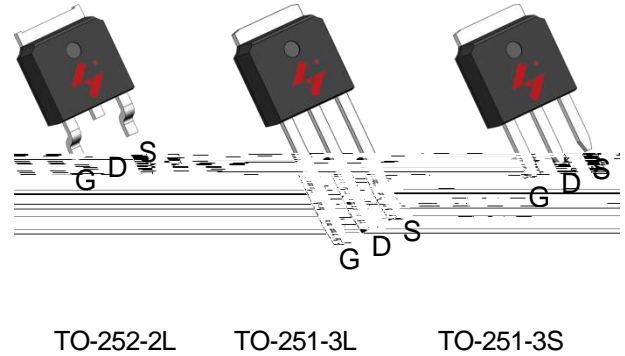

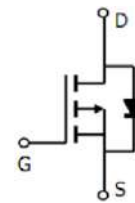

Applications

- z Switching application
- z Motor Drive



P-Channel MOSFET

Ordering and Marking Information

 D G450P06 XYMXXXXX	 U G450P06 XYMXXXXX	 V G450P06 XYMXXXXX	Package Code D: TO-252-2L U: TO-251-3L V: TO-251-3S Date Code XYMXXXXX
--	--	--	---

Note: HUAYI lead-free products contain molding compounds/die attach materials and 100% matte tin plate Termination finish; which are fully compliant with RoHS. HUAYI lead-free products meet or exceed the lead-free requirements of IPC/JEDEC J-STD-020 for MSL classification at lead-free peak reflow temperature. HUAYI defines 'Green' to mean lead-free (RoHS compliant) and halogen free (Br or Cl does not exceed 900ppm by weight in homogeneous material and total of Br and Cl does not exceed 1500ppm by weight).

HUAYI reserves the right to make changes to improve reliability or manufacturability without notice, and Advise customers to obtain the latest version of relevant information to verify before placing orders.

Absolute Maximum Ratings

Symbol	Parameter	Rating	Unit
Common Ratings (Tc=25°C Unless Otherwise Noted)			
V _{DSS}	Drain-Source Voltage	-60	V
V _{GSS}	Gate-Source Voltage	±20	V
T _J	Junction Temperature Range	-55 to 175	°C
T _{STG}	Storage Temperature Range	-55 to 175	°C
I _S	Drain Current-Continuous	Tc=25°C -20	A
Mounted on Large Heat Sink			
I _{DM}	Pulsed Drain Current *	Tc=25°C -80	A
I _D	Continuous Drain Current	Tc=25°C -20	A
		Tc=100°C -14	A
P _D	Maximum Power Dissipation	Tc=25°C 37.5	W
		Tc=100°C 18.7	W
R _{θJC}	Thermal Resistance, Junction-to-Case	4	°C/W
R _{θJA}	Thermal Resistance, Junction-to-Ambient **	110	°C/W
E _{AS}	Single Pulsed-Avalanche Energy ***	L=0.3mH 58***	mJ

Note: * Repetitive rating; pulse width limited by max junction temperature.

** Surface mounted on FR-4 board.

*** Limited by T_{Jmax}, starting T_J=25°C, L = 0.3mH, R_G= 25Ω

Electrical Characteristics (Cont.) (Tc =25°C Unless Otherwise Noted)

Symbol	Parameter	Test Conditions	HYG450P06LA1			Unit
			Min	Typ	Max	

Dynamic Characteristics

Typical Operating Characteristics

Figure 1: Power Dissipation

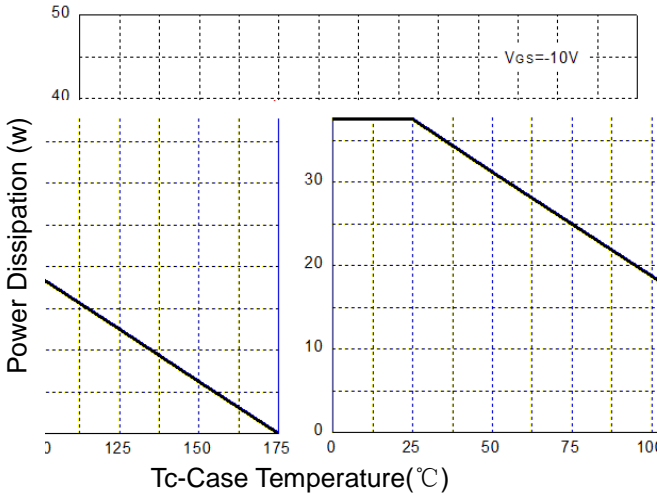

Figure 2: Drain Current

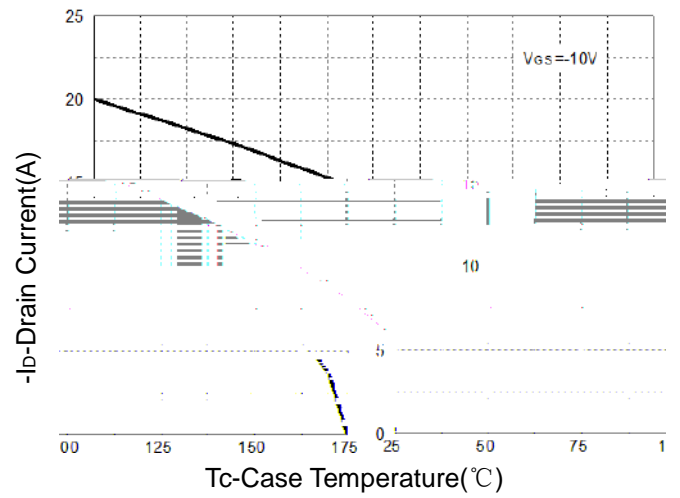

Figure 3: Safe Operation Area

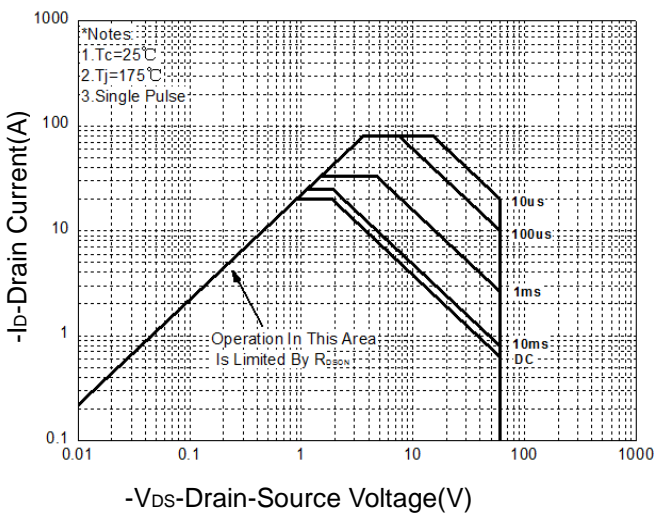

Figure 4: Thermal Transient Impedance

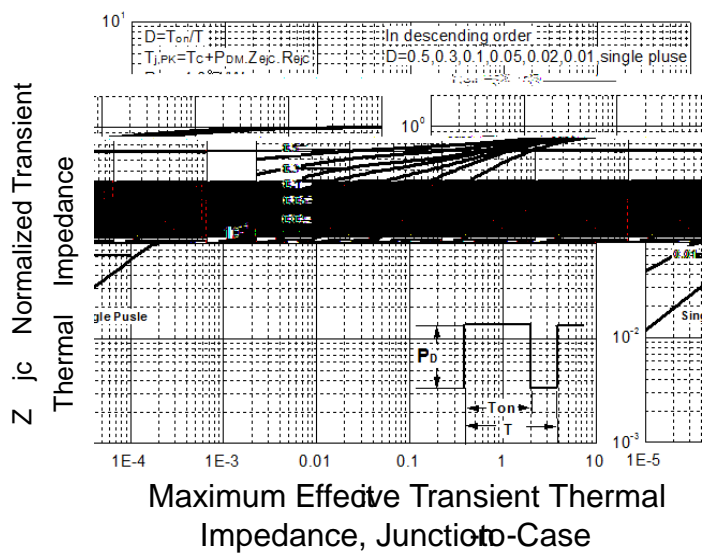

Figure 5: Output Characteristics

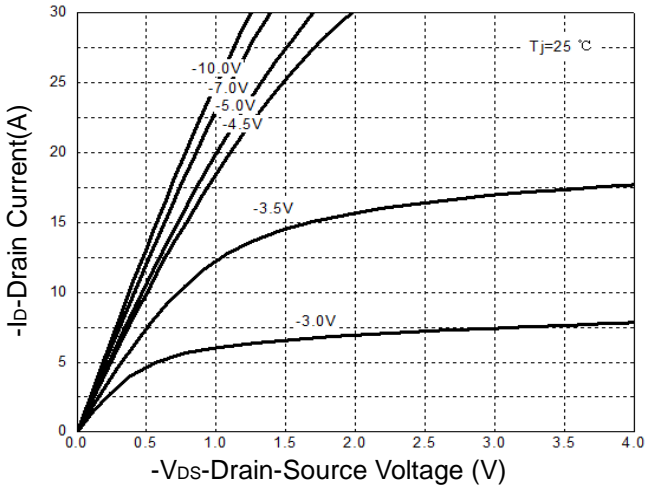
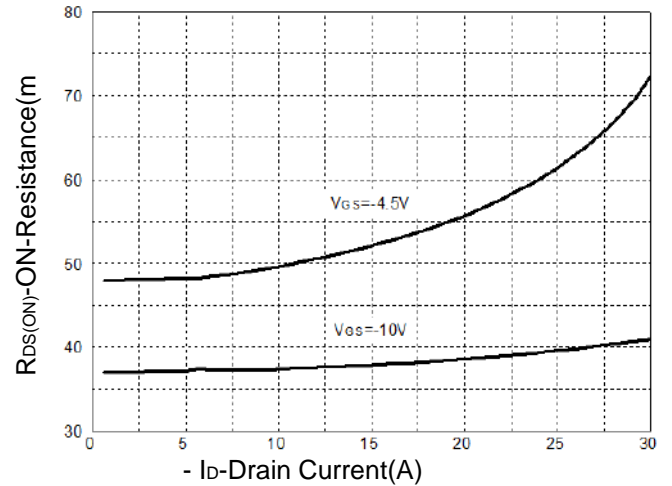

Figure 6: Drain -Source On Resistance



Typical Operating Characteristics (Cont.)

Figure 7: On -Resistance vs. Temperature

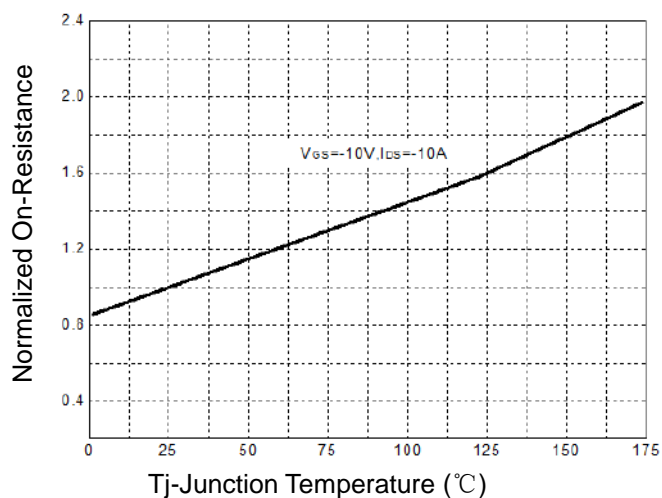

Figure 8: Source -Drain Diode Forward

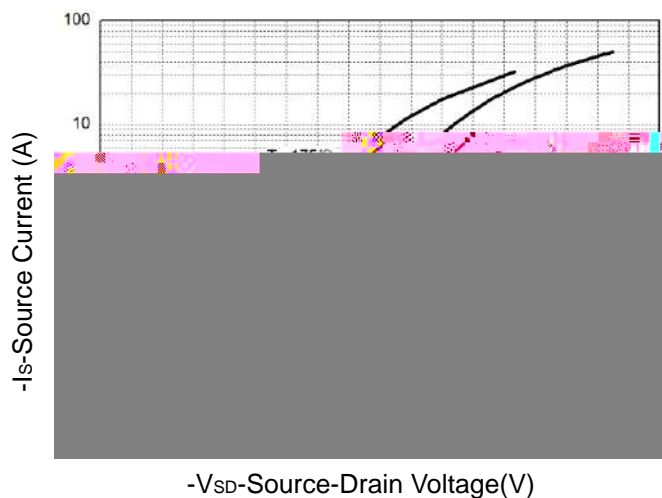

Figure 9: Capacitance Characteristics

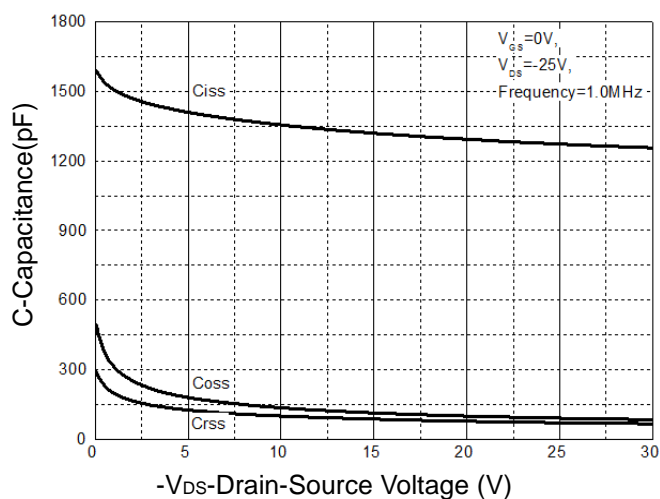
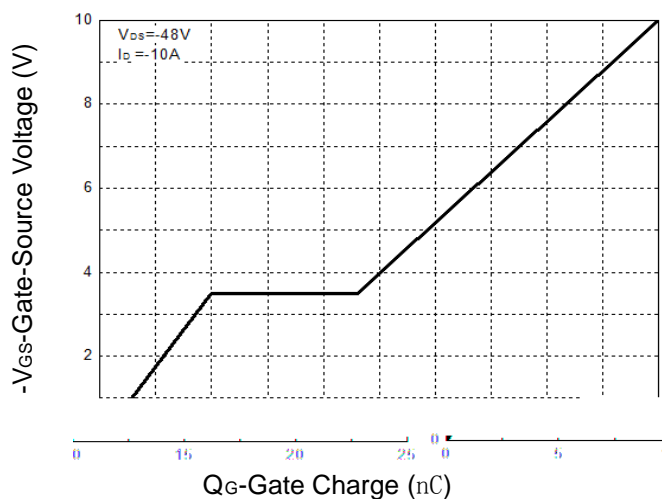
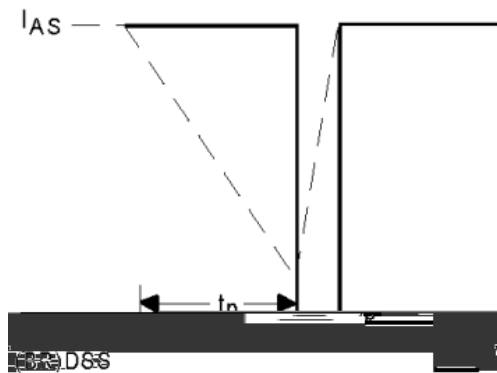
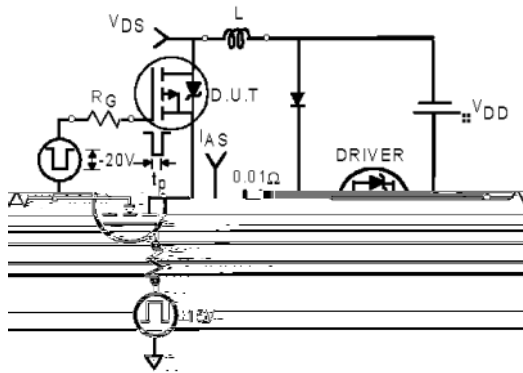

Figure 10: Gate Charge Characteristics



Avalanche Test Circuit



Switching Time Test Circuit

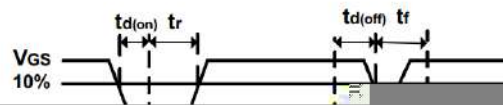
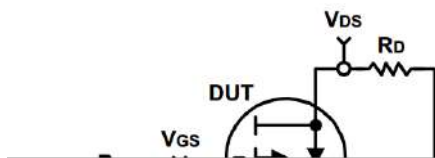

Gate Charge Test Circuit



Device Per Unit

Package Type	Unit	Quantity
TO-252-2L	Tube	75
TO-252-2L	Reel	2500
TO-251-3L	Tube	75
TO-251-3S	Tube	75

Package Information

TO-252-2L

COMMON DIMENSIONS

SYMBOL	mm		
	MIN	NOM	MAX
A	2.20	2.30	2.40
A1	0.00	-	0.20
A2	0.97	1.07	1.17
b	0.68	0.78	0.90
b3	5.20	5.33	5.50
c	0.43	0.53	0.63
D	5.98	6.10	6.22
D1	5.30REF		
E	6.40	6.60	6.80
E1	4.63	-	-
e	2.286BSC		
H	9.40	10.10	10.50
L	1.38	1.50	1.75
L1	2.90REF		
L2	0.51BSC		
L3	0.88	-	1.28
L4	-	-	1.00
L5	1.65	1.80	1.95
	0°	-	8°

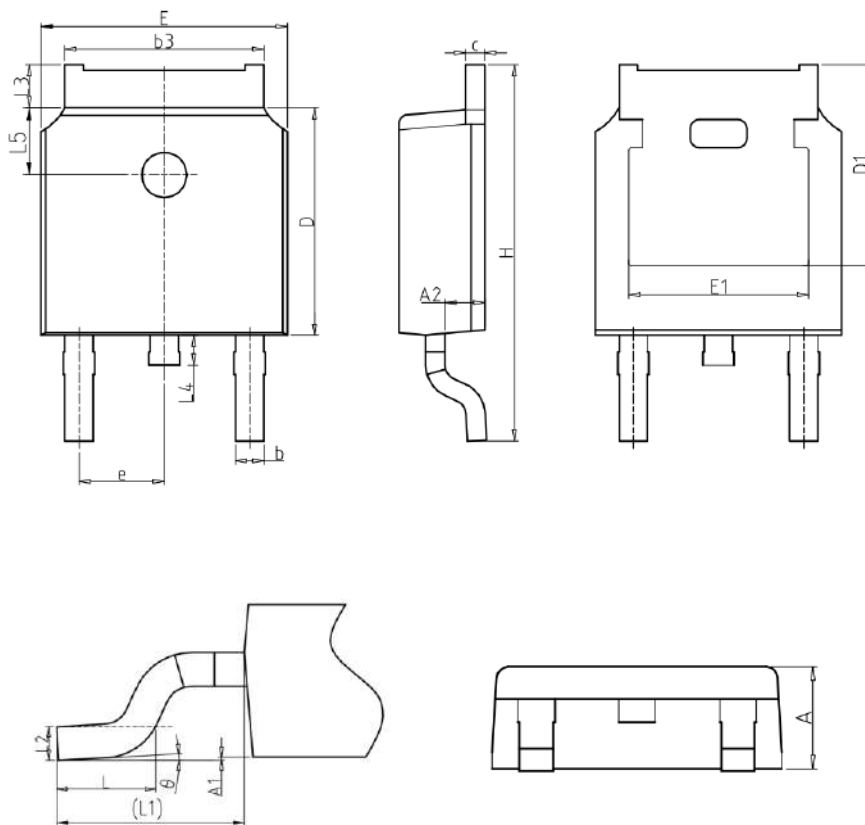

TO-251-3L

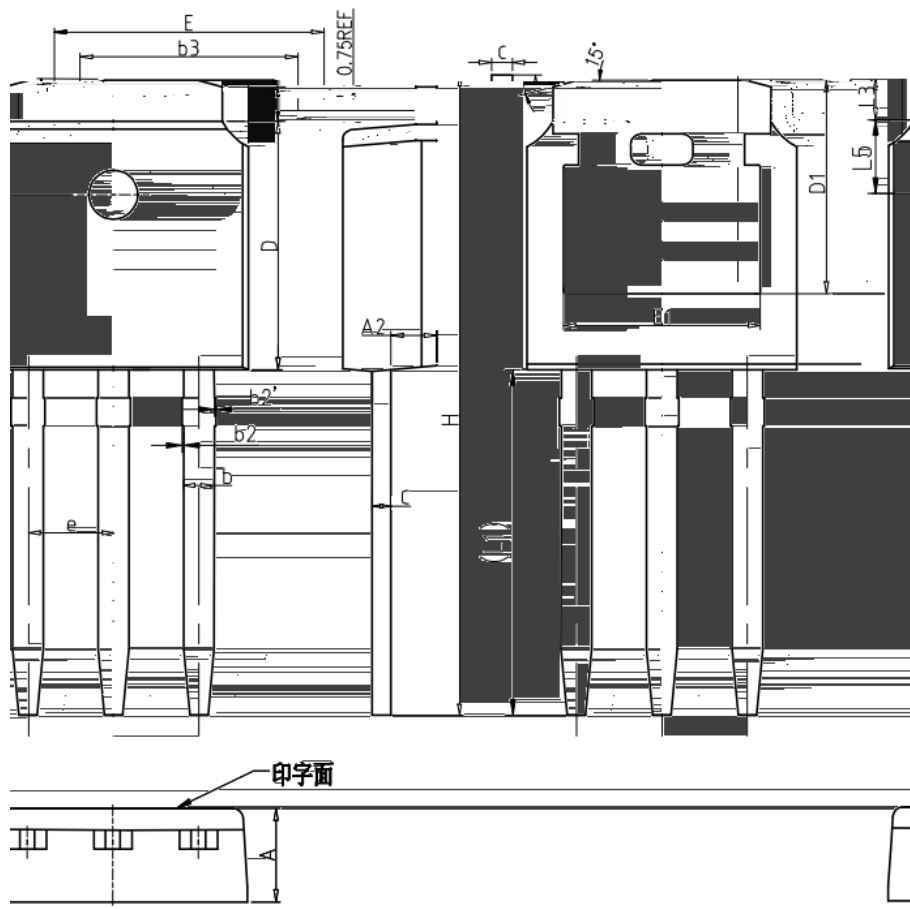

COMMON DIMENSIONS

SYMBOL	mm		
	MIN	NOM	MAX
A	2.20	2.30	2.40
A2	0.97	1.07	1.17
b	0.68	0.78	0.90
b2	0.00	0.04	0.10
b2'	0.00	0.04	0.10
b3	5.20	5.33	5.50
c	0.43	0.53	0.63
D	5.98	6.10	6.22
D1	5.30REF		
E	6.40	6.60	6.80
E1	4.63	-	-
e	2.286BSC		
H	16.22	16.52	16.82
L1	9.15	9.40	9.65
L3	0.88	1.02	1.28
L5	1.65	1.80	1.95

TO-251-3S

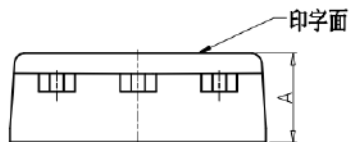
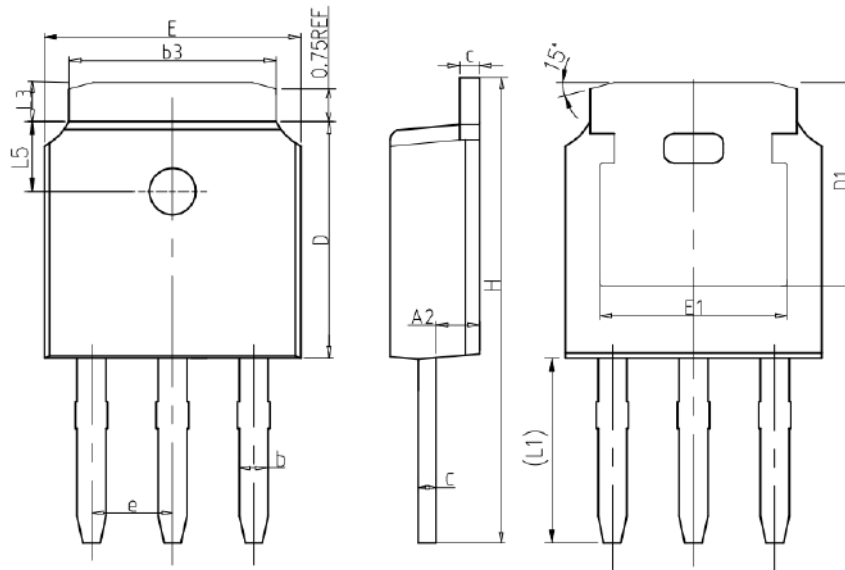

COMMON DIMENSIONS

SYMBOL	mm		
	MIN	NOM	MAX
A	2.20	2.30	2.40
A2	0.97	1.07	1.17
b	0.68	0.78	0.90
b3	5.20	5.33	5.50
c	0.43	0.53	0.63
D	5.98	6.10	6.22
D1	5.30REF		
E	6.40	6.60	6.80
E1	4.63	-	-
e	2.286BSC		
H	10.00	11.22	11.44
L1	3.90	4.10	4.30
L3	0.88	1.02	1.28
L5	1.65	1.80	1.95

Classification Profile

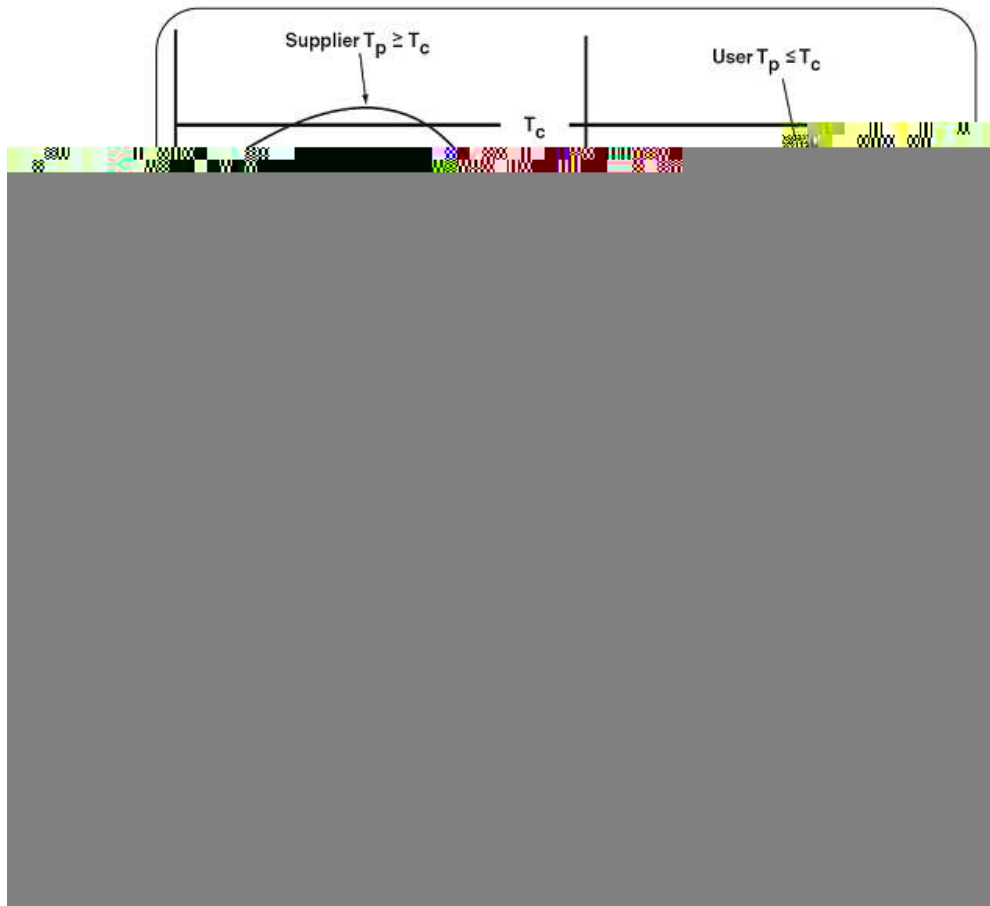

Classification Reflow Profiles

Profile Feature	Sn-Pb Eutectic Assembly	Pb-Free Assembly
Preheat & Soak		
Temperature min (T_{smin})	100 °C	150 °C
Temperature max (T_{smax})	150 °C	200 °C
Time (T_{smin} to T_{smax}) (t_s)	60-120 seconds	60-120 seconds
Average ramp-up rate (T_{smax} to T_p)	3 °C/second max.	3°C/second max.
Liquidous temperature (T_L)	183 °C	217 °C
Time at liquidous (t_L)	60-150 seconds	60-150 seconds
Peak package body Temperature (T_p)*	See Classification Temp in table 1	See Classification Temp in table 2
Time (t_p)** within 5°C of the specified classification temperature (T_c)	20** seconds	30** seconds
Average ramp-down rate (T_p to T_{smax})	6 °C/second max.	6 °C/second max.
Time 25°C to peak temperature	6 minutes max.	8 minutes max.
*Tolerance for peak profile Temperature (T_p) is defined as a supplier minimum and a user maximum.		
** Tolerance for time at peak profile temperature (t_p) is defined as a supplier minimum and a user maximum.		

Table 1. SnPb Eutectic Process ±Classification Temperatures (Tc)

Package Thickness	Volume mm ³ <350	Volume mm ³ ≥350
<2.5 mm	235 ℃	220 ℃
• P P	220 ℃	220 ℃

Table 2. Pb-free Process ±Classification Temperatures (Tc)

Package Thickness	Volume mm ³ <350	Volume mm ³ 350-2000	Volume mm ³ ≥2000
<1.6 mm	260 ℃	260 ℃	260 ℃
1.6 mm ±2.5 mm	260 ℃	250 ℃	245 ℃
≥2.5 mm	250 ℃	245 ℃	245 ℃